

REF.

NWAV S LED DIM UL

LIGHT SOURCE



120 - 277V: Dimmable 0-10V & TRIAC

Driver:

Constant Current 440mA

LED Integrated:

Led module

2700K, CRI90, 16W, 50-60Hz, 726 lm*

4000K, CRI90, 16W, 50-60Hz, 840 lm*

*Measurements taken using Blue exterior & Yellow interior.
Veneer Ref: 28 Blue & 24 Yellow

PACKAGING

Box size: 48 x 12 x 13"

Box volume: 4,5 ft³

Weight: Gross - 13,2 Lb | Net - 6,2 Lb

MATERIALS & COMPONENTS

Wood Veneer Shade

White Metal Structure









Nickel Metal Canopy: 14 x 4,6 x 2"

4 Steel Cables: 8 ft drop

Transparent Electrical Cable: 8 ft drop

FINISHES

WOOD VENEER COMBINATIONS

Exterior		Interior	
	21 Natural Cherry	with 	20 Ivory White
	26 Red	with 	24 Yellow
	28 Blue	with 	24 Yellow
	30 Turquoise	with 	24 Yellow

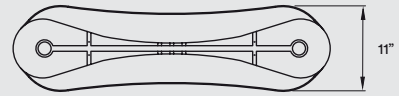
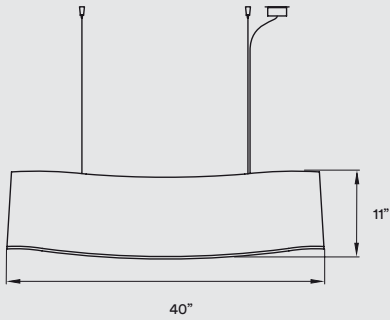
**REF.**

NWAV S E26 or GU 24 UL

LIGHT SOURCE

120 - 277V

Recommended Bulbs - Not Included

E26 Medium Base Lamp Holder
 2 LED A19 15 W, 1080 lm*
 or
 GU24 Lamp Holder
 2 LED A19 15 W, 1080 lm*

*Measurements obtained by theoretical calculations at LZf using ivory white shades & recommended bulbs.
 Veneer Ref: 20 Ivory White.

PACKAGING

Box size: 48 x 12 x 13"

Box volume: 4,5 ft³

Weight: Gross - 10,8 Lb | Net - 4,2 Lb

MATERIALS & COMPONENTS

Wood Veneer Shade









White Metal Structure

Nickel Metal Canopy: \varnothing 3,2"

4 Steel Cables: 8 ft drop

Transparent Electrical Cable: 8 ft drop

FINISHES**WOOD VENEER COMBINATIONS**

Exterior		Interior	
	21 Natural Cherry	with	 20 Ivory White
	26 Red	with	 24 Yellow
	28 Blue	with	 24 Yellow
	30 Turquoise	with	 24 Yellow