

# *punt*

ART, CRAFT & DESIGN



## DUNE

TECHNICAL INFORMATION SHEET

# DUNE

BY MONICA ARMANI, 2024

**punt**



---

## PRODUCT TYPE

Armchair

Dune, designed by Monica Armani, is presented as a symbol of elegance inspired by nature. Its shapes refer to the majestic striations that sand generates in desert dunes, capturing the organic beauty and serenity of the landscape. A piece capable of bringing sophistication to any project and evoking a sense of perpetual movement thanks to its soft, curved lines.

---

## TIPOLOGÍA DE PRODUCTO

Butaca

Dune, diseñado por Monica Armani, se presenta como un símbolo de elegancia inspirada en la naturaleza. Sus formas hacen referencia a las majestuosas estrías que la arena genera en las dunas del desierto, capturando la belleza orgánica y la serenidad del paisaje. Una pieza capaz de aportar sofisticación a cualquier proyecto y evocar una sensación de movimiento perpetuo gracias a sus líneas suaves y curvas.

## DETAILS DETALLES



# DUNE

BY MONICA ARMANI, 2024

**punt**

## DIMENSIONS. DIMENSIONES

---

### DUS100

Swivel base  
Base giratoria 

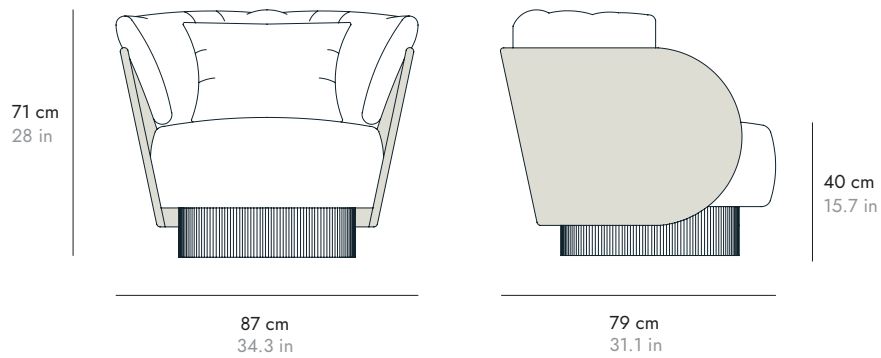

# DUNE

BY MONICA ARMANI, 2024

**punt**

## MATERIALS

Upholstery.  
BS standard fireproof foam (33kg and 40kg).  
Goose feather and siliconised fibre filled cushion.

Wood.  
Backrest made of resistant curved plywood board with natural oak veneer.

Base.  
Veneered plywood board with flexible textured lacquered MDF panel.

## Wooden top Sobre de madera

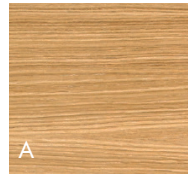

**SUPER MATT OAK**  
ROBLE SÚPER MATE  
CHENE SUPERMATE  
SUPER MATT EICHE  
ROVERE OPACO



**WHITENED OAK**  
ROBLE BLANQUEADO  
CHENE BLANCHI  
EICHE WEISS  
ROVERE SBIANCATO



**WALNUT STAINED OAK**  
ROBLE TEÑIDO NOGAL  
CHENE TEINTÉ NOYER  
EICHE NUSSBAUM  
GEBEIZT  
ROYERE TINTO NOLE

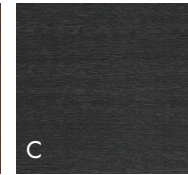

**DARK GREY STAINED OAK**  
ROBLE TEÑIDO GRIS  
CHENE TEINTE GRIS  
DUNKELGRAU GEBEIZTE  
EICHE  
ROVERE TINTO GRIGIO  
SCURO

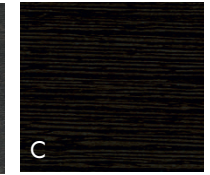

**EBONY STAINED OAK**  
ROBLE TEÑIDO ÉBANO  
CHENE TEINTÉ ÉBÔNE  
EICHE GEBEIZT  
EBENHOLZ  
ROVERE TINTO ÉBANO

## MATERIALES

Tapizados.  
Espumas ignífugas normativa BS (33kg y 40kg).  
Almohadón relleno de pluma de oca y fibra siliconada.

Madera.  
Respaldo fabricado en resistente tablero curvado de contrachapado chapado en madera de roble natural.

Base.  
Tablero de contrachapado chapado con panel flexible de MDF lacado texturizado.

## Base Base



**COPPER**  
COBRIZO  
CUIVRE  
KUPFER  
RAME



**GREEN FOREST**  
VERDE BOSQUE  
FOREST VERT  
WALDGRÜN  
VERDE FORESTA

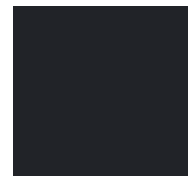

**BLACK**  
NEGRO  
NOIR  
SCHWARZ  
NERO



For special RAL colours, please consult Punt.

Para colores RAL especiales consultar con Punt.

## Fabrics G2

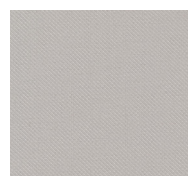

RELATE 101

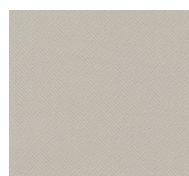

RELATE 201

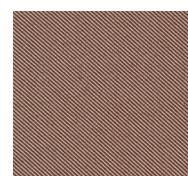

RELATE 341

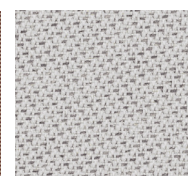

TONAL 60122



TONAL 61179

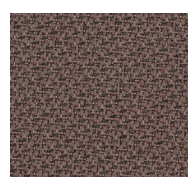

TONAL 64211



CASERTA 04



CASERTA 15

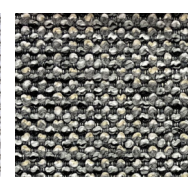

CASERTA 19



BACOLI 04

# DUNE

BY MONICA ARMANI, 2024

*punt*

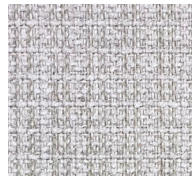

BACOLI 15

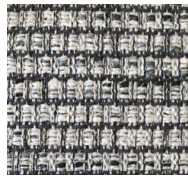

ODDI 09



MATIS 05



MATIS 07

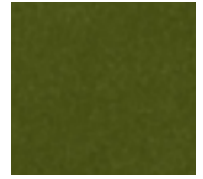

SEVEN 59

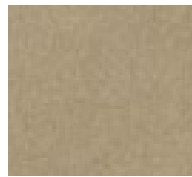

SEVEN 05



LEINEN 1049

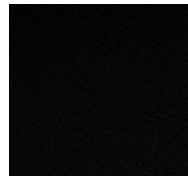

SCHWARZ 9035

## Fabrics G3

---



TEMPT 61169



TEMPT 61172



FIELD 232

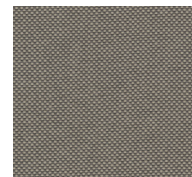

FIELD 242



REMUX 223



REMUX 233

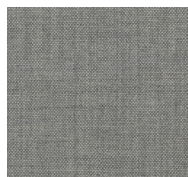

REMUX 123

## Fabrics G4

---



FOCUS 60309



FOCUS 61242

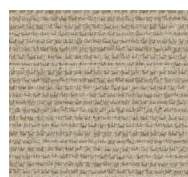

SAVANNA 202



SAVANNA 122

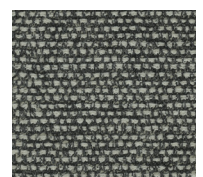

SAVANNA 152

# DUNE

BY MONICA ARMANI, 2024

*punt*

## Fabrics G5

---

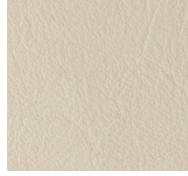

LAGUNA IVORY



LAGUNA SAND



LAGUNA STONE

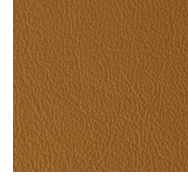

LAGUNA CAMEL

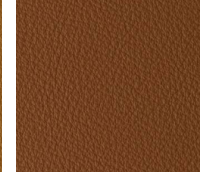

LAGUNA COGNAC



LAGUNA BROWN



LAGUNA BLACK