

# Sabot collection

PRODUCT SHEET



prostoría

# Sabot collection

by **BENJAMIN HUBERT | LAYER**

**Sabot** is a playful arrangement of abstract volumes supported by characterful timber feet that are a celebration of Prostoria's woodworking capability. The modular sofa system takes its name from a type of simple, timber shoe – a nod to these wooden feet. The soft and approachable design language is inspired by residential interiors, and brings a strong playful identity to commercial spaces. Each module has a super-soft, friendly silhouette that floats above the exposed timber legs in a cloud-like way, and these modules can be combined

to create linear or island configurations. The movable side accessories – including tables and dividers – mimic the floating language of these seating modules, while planters offer the ability to create green privacy screens. Sabot can be configured to create linear two-, three-, or four-seat sofas and asymmetrical S-shaped configurations that allow for added privacy between seating. The modules can also be connected together to form islands or clustered arrangements.

These flexible configurations of low table tops, poufs, and seating modules offer mixed capacity seating for dynamic spaces, such as break-out areas, lobbies, and receptions.

























SPECIFICATIONS AND TECHNICAL DRAWING

SUSPENSION	elastic webbing
SEAT & BACKREST	injected moulded foam
BASE	powder coated BLACK construction covered with oak solid wood
UPHOLSTERY	fabric (removable)
LOW TABLE	solid wood + oil or lacquer
PLANTER	PP (polypropylene) available in LIGHT GREY ≈ RAL 7047 / DARK GREY ≈ RAL 7015 / RED ≈ RAL 3031
PLANTER TOP	solid wood / MDF FENIX

[sofa information website](#)

[pouf information website](#)

MODULES

**1SEATER (M)**  
SEAT + BACKREST  
w 80 × d 97 × h 61 cm

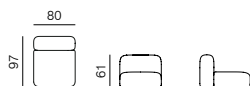

**CORNER (L/R)**  
SEAT + BACKREST + ARMREST  
w 97 d 97 × h 61 cm



**DEEP SEAT (M)**  
POUF  
w 80 × d 97 × h 28 cm

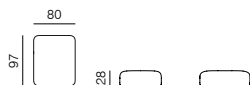

**ARMREST (A)**  
dimensions 29 × 97 × 50 cm

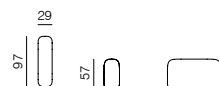

**PLANTER (A)**  
dimensions 27 × 97 × 32 cm



**PLANTER TOP**  
dimensions 27 × 97 × 2,5 cm (wood)  
dimensions 27 × 97 × 2 cm (FENIX)

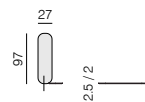

BASES

**BASE 01**  
M  
w 80 × d 97 cm



**BASE 02**  
M + A  
w 107 × d 97 cm



**BASE 03**  
M + 2A  
w 134 × d 97 cm



**BASE 04**  
2M  
w 160 × d 97 cm



**BASE 05**  
2M + A  
w 187 × d 97 cm



**BASE 06**  
2M + 2A  
w 214 × d 97 cm

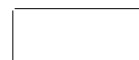

**BASE 07**  
CORNER  
w 97 × d 97 cm



LEGS

**L1**  
LEG  
w 15 × d 4,5 × h 29,5 cm



**L3**  
LINEAR CONNECTION SET

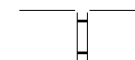

**L2**  
SMALL ARMREST TABLE  
w 49 × d 49 × h 68 cm



**L4**  
CORNER CONNECTION SET



**LOW TABLE 39**  
dimensions 96 × 39 × 30 cm



**LOW TABLE 39 WITH CHARGER**  
dimensions 96 × 39 × 30 cm



**LOW TABLE 79**  
dimensions 96 × 79 × 30 cm



**LOW TABLE 79 WITH CHARGER**  
dimensions 96 × 79 × 30 cm



**POWER SOCKET**  
dimensions 11,5 × 7 × 5,5 cm



SPECIFICATIONS AND TECHNICAL DRAWING

COMPOSITIONS

COMPOSITION 1

dimensions 80 × 97 × 42 cm

CONSISTS OF: BASE 01, MODULE DEEP SEAT, LEGS 4 × L1

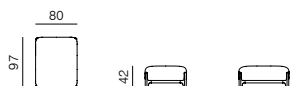

COMPOSITION 2 (L/R)

dimensions 160 × 97 × 75 cm

CONSISTS OF: BASE 04, MODULES 1SEATER + DEEP SEAT, LEGS 4 × L1

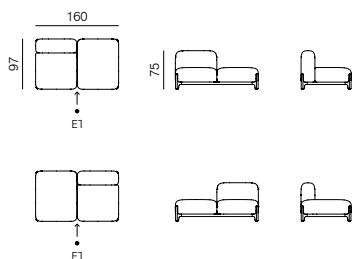

COMPOSITION 3 (L/R)

dimensions 187 × 97 × 75 cm

CONSISTS OF: BASE 05, MODULES 1SEATER + DEEP SEAT + PLANTER, LEGS 4 × L1

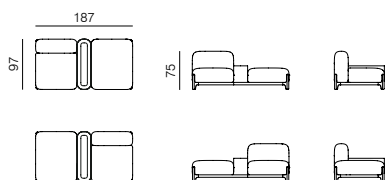

COMPOSITION 4 (L/R)

dimensions 187 × 97 × 75 cm

CONSISTS OF: BASE 05, MODULES 1SEATER + DEEP SEAT + ARMREST, LEGS 4 × L1

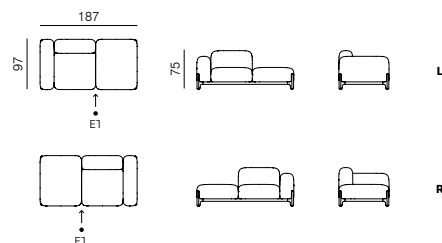

COMPOSITION 5 (L/R)

dimensions 214 × 97 × 75 cm

CONSISTS OF: BASE 06, MODULES 1SEATER + DEEP SEAT + ARMREST + PLANTER, LEGS 4 × L1

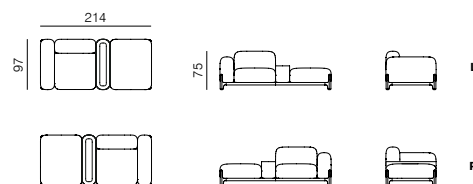

COMPOSITION 6 (L/R)

dimensions 214 × 97 × 75 cm

CONSISTS OF: BASE 06, MODULES 1SEATER + DEEP SEAT + ARMREST + PLANTER, LEGS 4 × L1

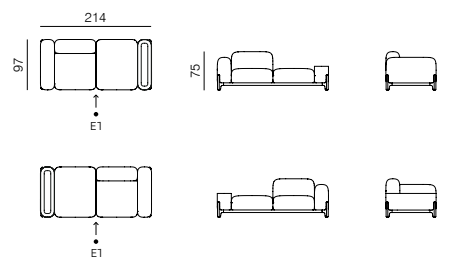

COMPOSITION 7 (L/R)

dimensions 241 × 97 × 75 cm

CONSISTS OF: BASES 02 + 03, MODULES 1SEATER + DEEP SEAT + 2 × ARMREST + PLANTER, LEGS L3 + 4 × L1

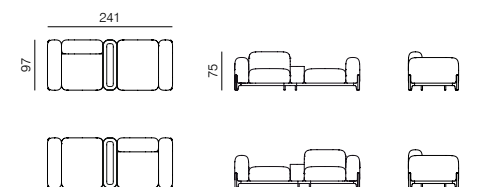

COMPOSITION 8 (L/R)

dimensions 240 × 97 × 75 cm

CONSISTS OF: BASES 01 + 04, MODULES 2 × 1SEATER + DEEP SEAT, LEGS L3 + 4 × L1

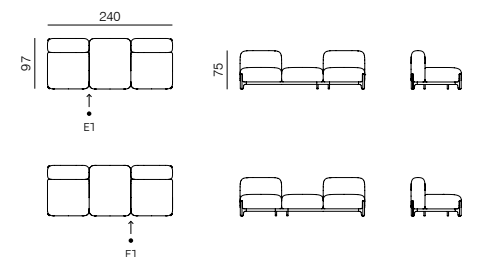

COMPOSITION 9 (L/R)

dimensions 267 × 97 × 75 cm

CONSISTS OF: BASES 04 + 02, MODULES 2 × 1SEATER + DEEP SEAT + ARMREST, LEGS L3 + 4 × L1

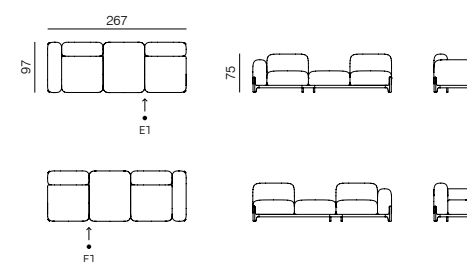

SPECIFICATIONS AND TECHNICAL DRAWING

**COMPOSITION 10 (L/R)**

dimensions 267 x 97 x 75 cm

CONSISTS OF: BASES O4 + O2, MODULES 2 x 1SEATER + DEEP SEAT +  
PLANTER, LEGS L3 + 4 x L1

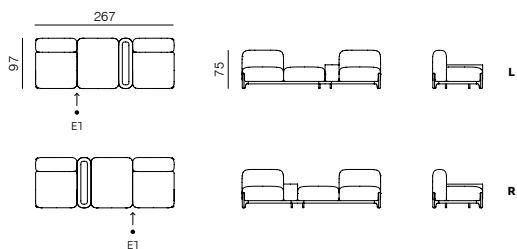

**COMPOSITION 13 (L/R)**

dimensions 294 x 97 x 75 cm

CONSISTS OF: BASES O5 + O2, MODULES 3 x 1SEATER + 2 x ARMREST,  
LEGS L3 + 4 x L1

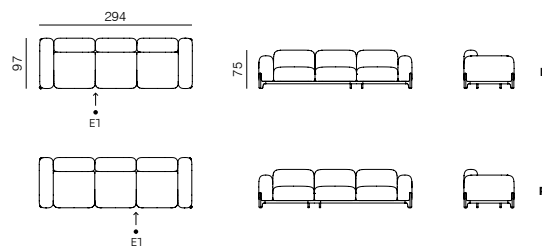

**COMPOSITION 16 (L/R)**

dimensions 347 x 97 x 75 cm

CONSISTS OF: BASES O5 + O4, MODULES 2 x 1SEATER + 2 x DEEP SEAT +  
PLANTER, LEGS L3 + 4 x L1

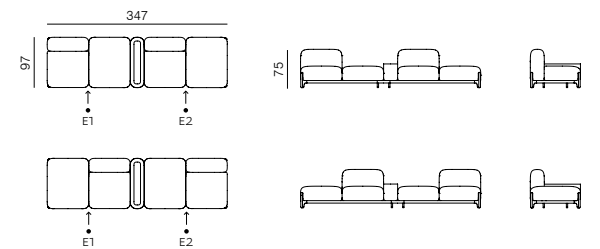

**COMPOSITION 11 (L/R)**

dimensions 294 x 97 x 75 cm

CONSISTS OF: BASES O4 + O3, MODULES 2 x 1SEATER + DEEP SEAT +  
ARMREST + PLANTER, LEGS L3 + 4 x L1

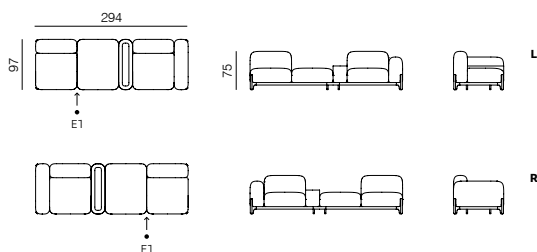

**COMPOSITION 14 (L/R)**

dimensions 321 x 97 x 75 cm

CONSISTS OF: BASES O5 + O3, MODULES 2 x 1SEATER + DEEP SEAT + 2 x ARMREST +  
PLANTER, LEGS L3 + 4 x L1

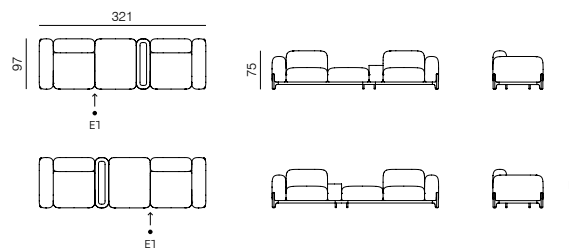

**COMPOSITION 17 (L/R)**

dimensions 374 x 97 x 75 cm

CONSISTS OF: BASES O5 + O4, MODULES 2 x 1SEATER + 2 x DEEP SEAT + ARMREST,  
LEGS L3 + 4 x L1

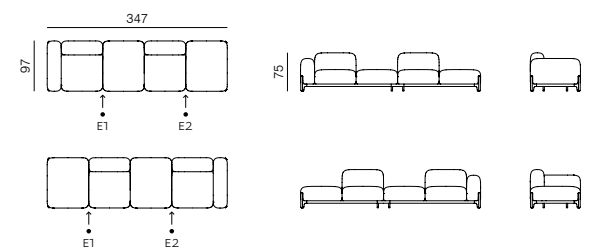

**COMPOSITION 12 (L/R)**

dimensions 294 x 97 x 75 cm

CONSISTS OF: BASES O5 + O2, MODULES 2 x 1SEATER + DEEP SEAT + ARMREST +  
PLANTER, LEGS L3 + 3 x L1 + L2

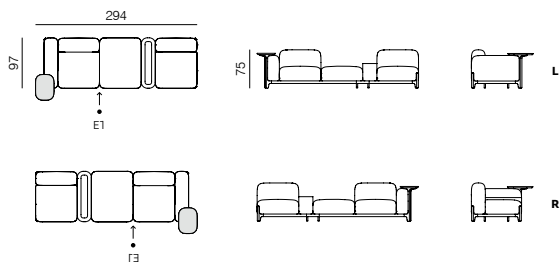

**COMPOSITION 15 (L/R)**

dimensions 320 x 97 x 75 cm

CONSISTS OF: BASES 2 x O4, MODULES 2 x 1SEATER + 2 x DEEP SEAT,  
LEGS L3 + 4 x L1

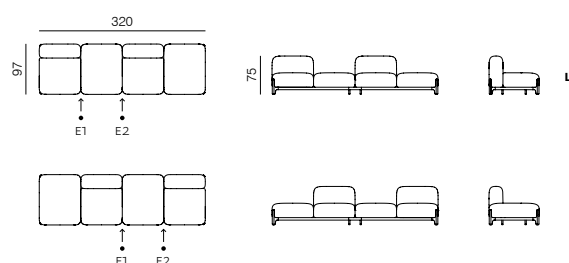

**COMPOSITION 18**

dimensions 374 x 97 x 75 cm

CONSISTS OF: BASES 2 x O5, MODULES 2 x 1SEATER + 2 x DEEP SEAT + 2 x ARMREST,  
LEGS L3 + 4 x L1

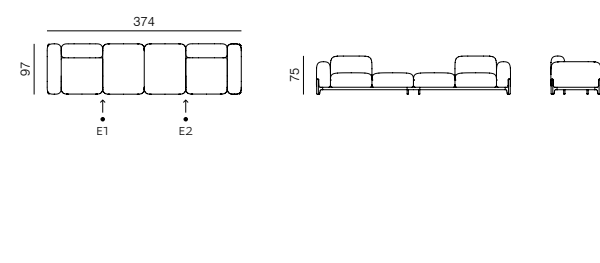

SPECIFICATIONS AND TECHNICAL DRAWING

**COMPOSITION 19 (L/R)**

dimensions 374 × 97 × 75 cm

CONSISTS OF: BASES 2 × 05, MODULES 2 × 1SEATER + 2 × DEEP SEAT + ARMREST + PLANTER, LEGS L3 + 4 × L1

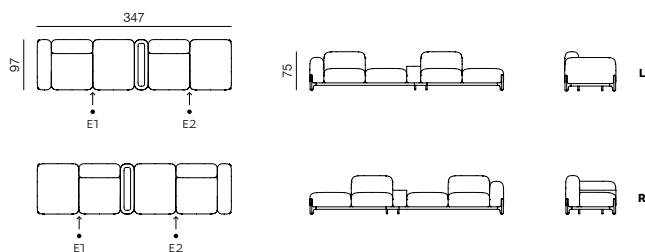

**COMPOSITION 20 (L/R)**

dimensions 401 × 97 × 75 cm

CONSISTS OF: BASES 06 + 05, MODULES 2 × 1SEATER + 2 × DEEP SEAT + 2 × ARMREST + PLANTER, LEGS L3 + 4 × L1

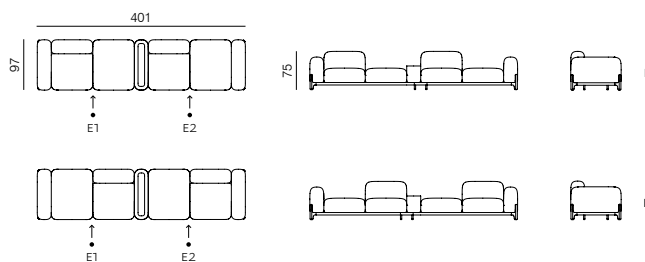

**COMPOSITION 21**

dimensions 177 × 177 × 75 cm

CONSISTS OF: BASES 2 × 01 + 07, MODULES 2 × 1SEATER + CORNER, LEGS L4 + 4 × L1

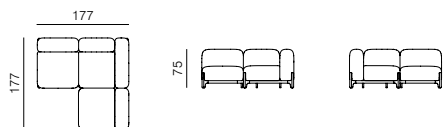

**COMPOSITION 22 (L/R)**

dimensions 177 × 204 × 75 cm

CONSISTS OF: BASES 02 + 01 + 07, MODULES 2 × 1SEATER + CORNER + ARMREST, LEGS L4 + 4 × L1

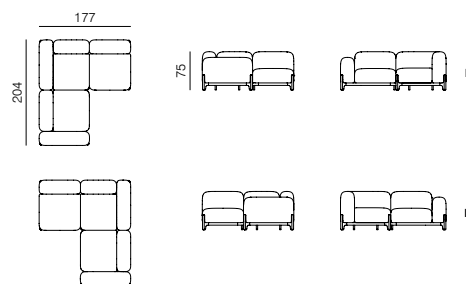

**COMPOSITION 23**

dimensions 204 × 204 × 75 cm

CONSISTS OF: BASES 2 × 02 + 07, MODULES 2 × 1SEATER + CORNER + 2 × ARMREST, LEGS L4 + 4 × L1

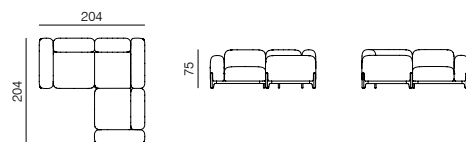

**COMPOSITION 24 (L/R)**

dimensions 257 × 177 × 75 cm

CONSISTS OF: BASES 01 + 07 + 04, MODULES 2 × 1SEATER + CORNER + DEEP SEAT, LEGS L4 + 4 × L1

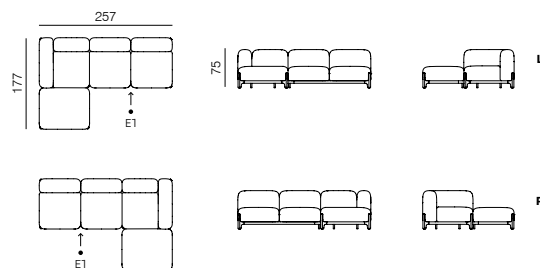

**COMPOSITION 25 (L/R)**

dimensions 284 × 177 × 75 cm

CONSISTS OF: BASES 05 + 07 + 01, MODULES 3 × 1SEATER + CORNER + ARMREST, LEGS L4 + 4 × L1

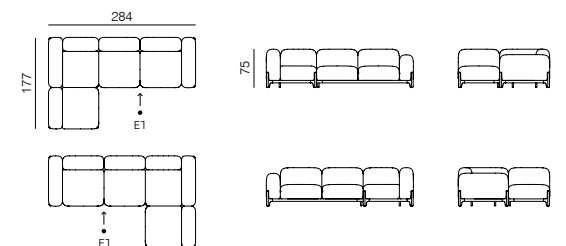

**COMPOSITION 26 (L/R)**

dimensions 257 × 257 × 75 cm

CONSISTS OF: BASES 2 × 04 + 07, MODULES 3 × 1SEATER + CORNER + DEEP SEAT, LEGS L4 + 4 × L1

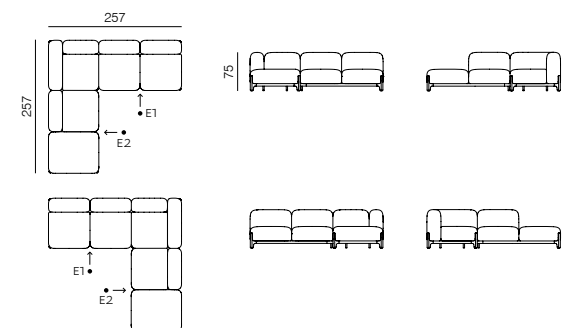

**COMPOSITION 27**

dimensions 257 × 204 × 75 cm

CONSISTS OF: BASES 04 + 07 + 02, MODULES 3 × 1SEATER + CORNER + ARMREST, LEGS L4 + 4 × L1

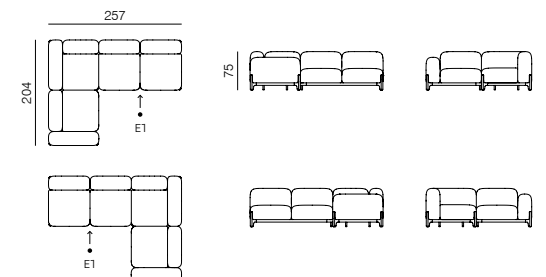



## SPECIFICATIONS AND TECHNICAL DRAWING

**COMPOSITION 28**

dimensions 257 × 257 × 75 cm

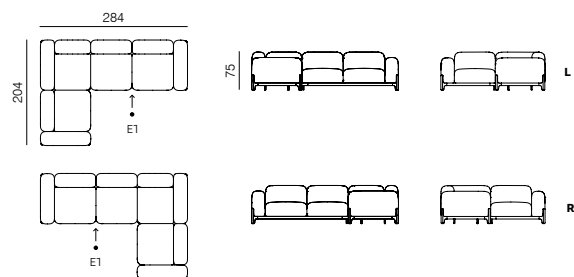
CONSISTS OF: BASES 05 + 07 + 02, MODULES 3 × 1SEATER + CORNER + 2 × ARMREST,  
LEGS L4 + 4 × L1**COMPOSITION 29**

dimensions 284 × 284 × 75 cm

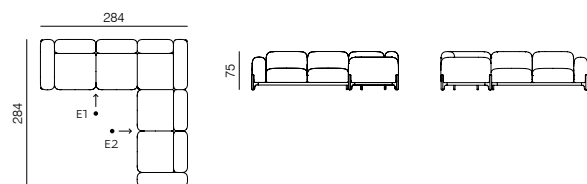
CONSISTS OF: BASES 2 × 05 + 07, MODULES 4 × 1SEATER + CORNER + 2 × ARMREST,  
LEGS L4 + 4 × L1**COMPOSITION 30**

dimensions 284 × 257 × 74 cm

CONSISTS OF: BASES 05 + 07 + 04, MODULES 3 × 1SEATER + CORNER + ARMREST +  
DEEP SEAT, LEGS L4 + 3 × L1 + L2